

User's Guide

**2000URX • 2000URX/Si/Si-S • 2000BT • 2000XT
ENHANCED BROADCAST PERFORMANCE
UHF WIRELESS SYSTEM**

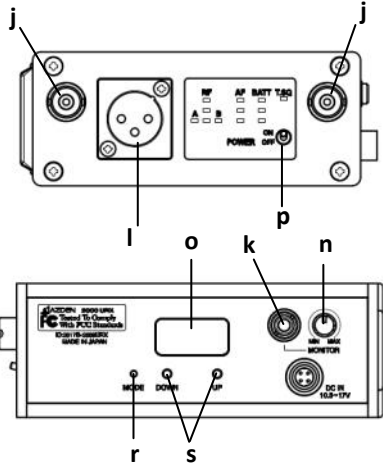

2000URX Receiver

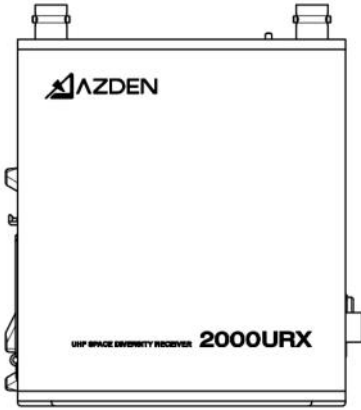

2000URX/Si Receiver

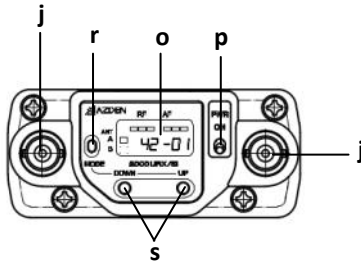
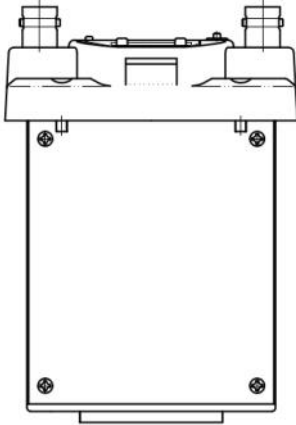

2000BT Transmitter

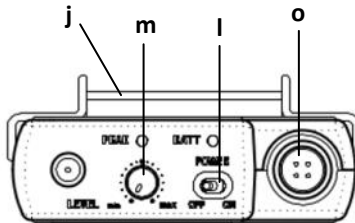
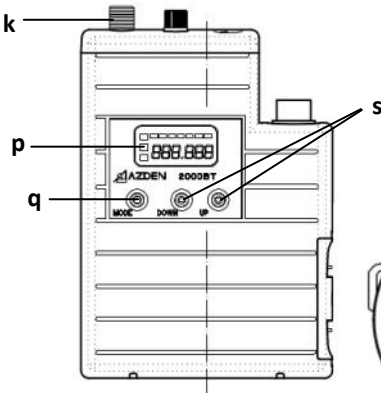

INTRODUCTION

Thank you for selecting the Azden 2000 Series for your portable/ENG on-camera UHF wireless needs. We are confident that these components will perform beyond your expectations. For over 50 years, Azden Corporation has been creating technologically advanced products. By taking advantage of the latest in CAD design and SMT production techniques, Azden's engineers are able to produce products that exceed the published specifications and perform well beyond the warranty period.

The 2000 Series represents a breakthrough in on-camera, digital frequency-selectable UHF receivers and transmitters. Its enhanced performance assures you of the highest image rejection combined with the finest in audio clarity. The PLL-synthesized mixer/local oscillator provides for extremely accurate frequency selection while the twin-antenna true diversity front-end reduces multi-path distortion caused dropouts to near zero.

In the real world of ENG, the ability to be able to select a "clear" frequency on the spot is vitally important. Going out into the field with a single-frequency unit invites disaster since there is no way of knowing what frequencies will be used by the other crews that are covering the same story or event. Think of the 2000 Series units as your insurance policy - Your assurance of getting the story.

Designed by professionals - For professionals, the 2000 Series will provide you with years of worry-free, high-quality performance.

TABLE OF CONTENTS

2000URX/Si RECEIVER AND 2000BT TRANSMITTER VIEW	i
INTRODUCTION	ii
RECEIVER 2000URX SETUP.....	1-2
Attaching the Antennas	1
Connecting the Output Cable	1
Setting the Receiver's Frequency	1-2
Power	2
Output	2
Monitor	2
LCD Display	2 & 4
THE 2000URX/Si.....	4
Mode	4-5
Up/Down	5
Powering the 2000BT Transmitter.....	6
SETTING THE TRANSMITTING FREQUENCY ON THE 2000BT	6-7
USING THE 2000BT TRANSMITTER'S CONTROLS AND DISPLAY	7
Power	7
Audio	7
MIC	7
Input Level Adjustment	7
Belt Clip	7
Antenna	7
Display	8
THE 2000XT.....	8
Powering the 2000XT	8-9
SETTING THE TRANSMITTING FREQUENCY ON THE 2000XT	9
2000XT TRANSMITTER VIEW	10
USING THE 2000XT TRANSMITTER'S CONTROLS AND DISPLAY	10
Power	10
Audio	10
MIC Connector / Locking Ring	10
Input Level Adjustment	10
Display	11
SPECIFICATIONS.....	Back
LICENSING.....	Back

RECEIVER SETUP (2000URX)

Improving the performance of the highly regarded 2000 series was no easy task for Azden engineers. This involved a completely new circuit design, for the crystal-controlled PLL synthesized 2000 Series. The new design has dramatically improved audio quality, with lower noise levels, increased dynamic range and transient response. A new system IC has improved system stability and, at the same time, lowered power consumption. Regardless of climate conditions, the new IC design offers consistent system performance for the most demanding ENG/EFP broadcast applications. The 2000 Series is available in several receiver configurations for compatibility with most broadcast cameras. The matching 2000BT body-pack and 2000XT transmitters are housed in a durable die-cast case.

A. Attaching antennas:

To attach the antennas to the receiver, fit the BNC connector of the antenna on the receiver [j], press down and rotate clockwise. To remove, rotate the antenna's BNC connector counterclockwise and pull up.

Azden's 2000 series receivers come with 2 sets of antennas. The standard high-gain antennas (95.3 mm in length) can expect to perform with a range of up to 70-80 meters. The shorter antennas (23.8 mm in length) are best suited for when space and movement is limited, to prevent accidental damage. Even with their shorter length, these antennas can expect to perform at a range of up to 60-70 meters.

B. Connecting the Output cable:

It is necessary to connect the output of the receiver [l] to the camera's "MIC" or "LINE" input by means of a properly wired cable (not supplied). The connector on the receiver is wired with pin #1 as Ground, pin #2 as Positive (+) and pin #3 as Negative (-). Set the OUTPUT Line/Mic switch on the receiver [q] to the appropriate position, matching the input on the camera that is used.

C. Setting the Receiving Frequency:

Before the receiver can be used, it and the associated transmitter have to be set to the same frequency. This can be accomplished on the receiver by first setting the LCD display to one of two views - "Frequency" or "Channel".

RECEIVER SETUP/USE – 2000URX (continued)

To do this, after applying battery power, first turn the receiver to the ON position [p]. Next, using the tip of a ballpoint pen, an unbent paperclip or something similar, press the MODE button [r] repeatedly until one of the two screens on the next page appears.



Using either the UP or DOWN button [s] the desired receiving frequency or channel number can be set. Tapping the button steps through the frequency or channel number one at a time while pressing and holding the button moves through the frequencies or channel numbers rapidly. There are 188 different frequencies or channel numbers to choose from. Once the desired frequency or channel has been determined be certain to set both the transmitter and the receiver to match.

D. Power:

The POWER ON/OFF switch [p] turns the 2000URX On and Off. To conserve battery life, it is best to turn the receiver ON only when it is actually being used.

E. Monitor:

This control [n] adjusts the output level (MIN to MAX) at the earphone monitor jack [k]. This is a 3.5mm mono jack.

F. LCD Display:

This display [o] shows several pieces of information. As discussed previously, the frequency or channel number is shown. Additionally, as the diversity receiver chooses which antenna is receiving the best signal, the “A” or “B” segment of the LCD display will illuminate.

Frequency	Display	Frequency	Display	Frequency	Display	Frequency	Display
638.125	42-01	644.125	43-01	650.125	44-01	656.125	45-01
638.250	42-02	644.250	43-02	650.250	44-02	656.250	45-02
638.375	42-03	644.375	43-03	650.375	44-03	656.375	45-03
638.500	42-04	644.500	43-04	650.500	44-04	656.500	45-04
638.625	42-05	644.625	43-05	650.625	44-05	656.625	45-05
638.750	42-06	644.750	43-06	650.750	44-06	656.750	45-06
638.875	42-07	644.875	43-07	650.875	44-07	656.875	45-07
639.000	42-08	645.000	43-08	651.000	44-08	657.000	45-08
639.125	42-09	645.125	43-09	651.125	44-09	657.125	45-09
639.250	42-10	645.250	43-10	651.250	44-10	657.250	45-10
639.375	42-11	645.375	43-11	651.375	44-11	657.375	45-11
639.500	42-12	645.500	43-12	651.500	44-12	657.500	45-12
639.625	42-13	645.625	43-13	651.625	44-13	657.625	45-13
639.750	42-14	645.750	43-14	651.750	44-14	657.750	45-14
639.875	42-15	645.875	43-15	651.875	44-15	657.875	45-15
640.000	42-16	646.000	43-16	652.000	44-16	658.000	45-16
640.125	42-17	646.125	43-17	652.125	44-17	658.125	45-17
640.250	42-18	646.250	43-18	652.250	44-18	658.250	45-18
640.375	42-19	646.375	43-19	652.375	44-19	658.375	45-19
640.500	42-20	646.500	43-20	652.500	44-20	658.500	45-20
640.625	42-21	646.625	43-21	652.625	44-21	658.625	45-21
640.750	42-22	646.750	43-22	652.750	44-22	658.750	45-22
640.875	42-23	646.875	43-23	652.875	44-23	658.875	45-23
641.000	42-24	647.000	43-24	653.000	44-24	659.000	45-24
641.125	42-25	647.125	43-25	653.125	44-25	659.125	45-25
641.250	42-26	647.250	43-26	653.250	44-26	659.250	45-26
641.375	42-27	647.375	43-27	653.375	44-27	659.375	45-27
641.500	42-28	647.500	43-28	653.500	44-28	659.500	45-28
641.625	42-29	647.625	43-29	653.625	44-29	659.625	45-29
641.750	42-30	647.750	43-30	653.750	44-30	659.750	45-30
641.875	42-31	647.875	43-31	653.875	44-31	659.875	45-31
642.000	42-32	648.000	43-32	654.000	44-32	660.000	45-32
642.125	42-33	648.125	43-33	654.125	44-33	660.125	45-33
642.250	42-34	648.250	43-34	654.250	44-34	660.250	45-34
642.375	42-35	648.375	43-35	654.375	44-35	660.375	45-35
642.500	42-36	648.500	43-36	654.500	44-36	660.500	45-36
642.625	42-37	648.625	43-37	654.625	44-37	660.625	45-37
642.750	42-38	648.750	43-38	654.750	44-38	660.750	45-38
642.875	42-39	648.875	43-39	654.875	44-39	660.875	45-39
643.000	42-40	649.000	43-40	655.000	44-40	661.000	45-40
643.125	42-41	649.125	43-41	655.125	44-41	661.125	45-41
643.250	42-42	649.250	43-42	655.250	44-42	661.250	45-42
643.375	42-43	649.375	43-43	655.375	44-43	661.375	45-43
643.500	42-44	649.500	43-44	655.500	44-44	661.500	45-44
643.625	42-45	649.625	43-45	655.625	44-45	661.625	45-45
643.750	42-46	649.750	43-46	655.750	44-46	661.750	45-46
643.875	42-47	649.875	43-47	655.875	44-47	661.875	45-47

[GR-1 ~ 6]

Group Disp - Freq.	CH 01	CH 02	CH 03	CH 04	CH 05	CH 06	CH 07	CH 08	CH 09	CH 10	CH 11	CH 12
GR 1	638.625	639.750	641.125	643.125	643.875	645.500	646.000	647.750	648.625	649.000	649.250	
GR 2	644.125	644.625	645.375	647.125	647.500	648.500	649.125	649.375				
GR 3	638.375	639.625	640.250	641.250	642.625	643.000	643.500	643.750				
GR 4	650.625	651.750	653.125	655.125	655.875	657.500	658.000	659.750	660.625	661.000	661.250	
GR 5	656.125	656.625	657.375	659.125	659.500	660.500	661.125	661.375				
GR 6	650.375	651.625	652.250	653.250	654.625	655.000	655.500	655.750				
Group Disp - CH.	CH 01	CH 02	CH 03	CH 04	CH 05	CH 06	CH 07	CH 08	CH 09	CH 10	CH 11	CH 12
GR 1	42 - 05	42 - 14	42 - 25	42 - 41	42 - 47	43 - 12	43 - 16	43 - 30	43 - 37	43 - 40	43 - 42	
GR 2	43 - 01	43 - 05	43 - 11	43 - 25	43 - 28	43 - 36	43 - 41	43 - 43				
GR 3	42 - 03	42 - 13	42 - 18	42 - 26	42 - 37	42 - 40	42 - 44	42 - 46				
GR 4	44 - 05	44 - 14	44 - 25	44 - 41	44 - 47	45 - 12	45 - 16	45 - 30	45 - 37	45 - 40	45 - 42	
GR 5	45 - 01	45 - 05	45 - 11	45 - 25	45 - 28	45 - 36	45 - 41	45 - 43				
GR 6	44 - 03	44 - 13	44 - 18	44 - 26	44 - 37	44 - 40	44 - 44	44 - 46				

RECEIVER SETUP/USE - 2000URX (continued)

As the RF signal from the transmitter gets stronger (or weaker) the number of illuminated LCD segments in the display will change - with 3 segments being the maximum and best. Similarly, the AF (audio level) segments will light from 1 to 3 segments as the audio gets stronger or weaker. In this case, the best level is achieved as the display shows between 2 and 3 segments. If all 3 segments stay illuminated for a continued period of time it is likely that you are over-driving the receiver's input and you should reduce the transmitting level by either moving the microphone further away from the sound source or reducing the input gain on the transmitter.

THE 2000URX/Si

The 2000URX/Si receiver is specially designed to work with specific Panasonic "Slot-In" or Ikegami "Uni-Slot" cameras. Once mounted in the camera, the DB-25 connector on the bottom provides the receiver with power directly from the camera's power supply (battery) while delivering audio directly to the camera's audio input. Items A. [j], C., D. [p] and F. [o] on pages 1 and 2 apply directly to the 2000URX/Si.

2000URX/Si Top panel display and operation:

The MODE Switch [r] performs 1 of 5 functions.

Initial MODE display:

The initial MODE shows the receiving band shown as Group, Channel and Frequency. If there is no action taken with the MODE switch for 4 seconds the display will return to the Initial Display. Pressing the MODE switch for one second while showing the Initial Display will cause the currently set frequency to be displayed.

Mode #1 (GR):

From the Initial Display, quickly pressing the MODE switch once displays the Group Display. Pressing the UP or DOWN buttons will change the Group Number. There are 7 Groups, 6 of which have the best selection of frequency combinations when using multiple systems. Group 0 allows for choosing any channel/frequency. The last used Group is memorized when the receiver is turned OFF. The chart on page 3 shows the Group vs Frequency combinations.

2000URX/Si Top Panel display and operation (continued)

Mode #2 (CH):

To change the channel/frequency within the selected group, press the MODE switch a 2nd time. "CH" will be displayed. Using either the UP or DOWN buttons [s] the desired receiving channel/frequency combination can be set (the chart on page 3 shows the relationship). Tapping the button steps the channel/frequency number one at a time while pressing and holding the button moves through the combinations rapidly. There are 188 different channel/ frequency combinations to choose from ("Group" allows you to select all of the combinations). Once the desired channel/frequency has been determined, set both the transmitter and receiver to match. When the receiver is turned OFF, the last channel/frequency chosen is stored in memory.

Mode #3 (SQ):

To change the squelch level, press the MODE switch for a third time. "SQ" will show in the display. There are 3 settings to choose from:

on on = RF mute ON - Tone mute ON (default)

on off = RF mute ON - Tone mute OFF

off off = RF mute OFF - Tone mute OFF

You can cycle through these with the UP/DOWN buttons. The squelch returns to the default when the receiver is turned OFF.

Mode #4 (SQ Level):

There are four levels of Squelch to choose from:

0 =Default

3 = 3dB (RF) increase to the default

-6 = 6dB (RF) decrease to the default

-3 = 3dB (RF) decrease to the default

You can cycle through these with the UP/DOWN buttons.

See the discussion at the bottom of page 2 and the top of page 4 for information concerning the other parts of the display.

Powering the 2000BT Transmitter

The 2000BT uses 2 AA alkaline batteries for power. The batteries are placed in the battery compartment by squeezing the 2 metal tabs on the side of the unit, releasing the battery door. Slide the battery compartment out, placing the batteries in the compartment as marked. Note: **DO NOT FORCE THE BATTERIES INTO THE COMPARTMENT**. Azden does not recommend the use of rechargeable batteries.

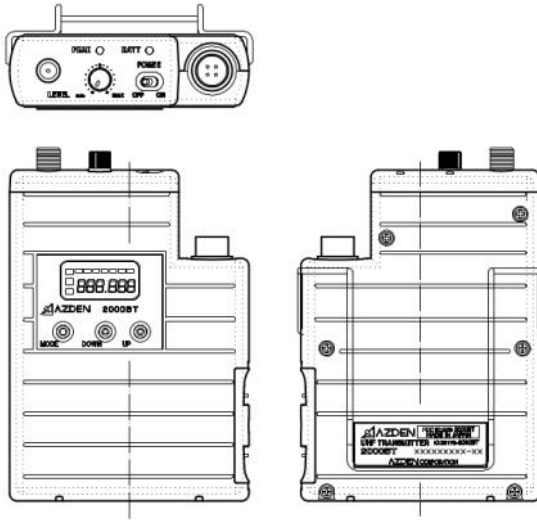

SETTING THE TRANSMITTING FREQUENCY ON THE 2000BT

Before the 2000BT can be used, it and the associated receiver have to be set to the same frequency. This can be accomplished on the 2000BT transmitter by first setting the LCD display to one of two views - “Frequency” or “Channel”. To do this, after installing fresh batteries, turn the 2000BT to the ON position [I]. Next, using the tip of a ballpoint pen, an unbent paper clip or something similar, press the MODE button [q] repeatedly until one of the two screens below appears.



Using either the UP or DOWN button [s] the desired receiving frequency or channel number can be set. Tapping the button steps through the frequency or channel number one at a time while pressing and holding the button moves through the frequencies or channel numbers rapidly. There are 188 different frequencies or channel numbers to choose from. Once the desired frequency or channel has been determined be certain to set both the transmitter and the receiver to match.

USING THE 2000BT TRANSMITTER CONTROLS AND DISPLAY

A. Power:

The POWER ON/OFF switch [l] turns the 2000BT On and Off.

B. MIC:

This 4-pin Hirose connector [o] is the microphone input. Azden produces a number of lapel, head-worn and neck-worn microphones that are specifically suited for the 2000BT. In addition, other externally powered (5VDC) electret condenser microphones can be used when they are properly wired with the correct Hirose connector) pin #1 is for audio +, pin #2 is not used, pin #3 is for bias voltage and pin #4 is ground). If you are using the 2000BT as a wireless instrument transmitter the connections are somewhat different (pin #1 is not used, pin #2 is audio +, pin #3 is for bias voltage and pin #4 is ground).

C. Input Level Adjustment:

This knob adjustment [m] controls the level of the microphone. Counter-clockwise rotation reduces the input gain while clockwise rotation increases the input gain.

D. Belt-Clip:

The metal belt-clip [j] provides a convenient method of attaching the transmitter to the user.

E. Antennas:

The antennas [k] should be kept clear of metal objects.

G. Display:

In addition to showing the frequency and channel number, the display [p] also shows other useful information.

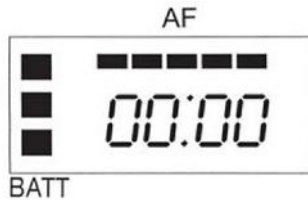

The LCD segments on the left show the approximate remaining battery life (from 1 to 3 segments) with 3 segments meaning maximum battery power. The bottom segment will blink when the battery power falls to less than 2.2VDC and indicates that it is time to replace the batteries. Azden recommends the use of Alkaline batteries only.

Across the top of the display, up to 5 segments will illuminate depending on the strength of the transmitted audio signal - From 2 (weak) to 5 (strong). The first (left) segment will light when the STBY switch is turned ON. The best audio is achieved when 4 to 5 segments are lit. If all 5 segments are lit continually, the signal is too strong and could overload the input of the receiver. Either move the microphone further away from the sound source or reduce the microphone input gain [m].

The display can also show the total number of hours of use (change to this display using the mode [q] button). To start, after choosing the TIME mode, press the UP [s] Button until the display shows 00:00. Then, each time the transmitter is turned ON the clock will keep track of the total hours and minutes used. This is a handy way of keeping track of battery life.

POWERING THE 2000XT TRANSMITTER

The 2000XT uses two AA Alkaline batteries for power. The batteries are placed in the compartment by removing the battery compartment door and placing the batteries in the compartment as shown.

POWERING THE 2000XT (continued)

In the illustration. The compartment is designed to ease battery insertion - With the correct polarity. **DO NOT FORCE THE BATTERY INTO THE COMPART - MENT.** Azden does not recommend the use of rechargeable batteries.

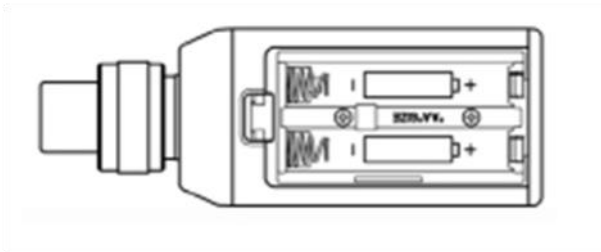

SETTING THE TRANSMITTING FREQUENCY ON THE 2000XT

Before the 2000XT can be used, it and the associated receiver have to be set to the same frequency. This can be accomplished on the 2000XT transmitter by first setting the LCD display to one of the two views - “Frequency” or “Channel”. To do this, after installing fresh batteries, turn the 2000XT to the ON position [r]. Next, using the tip of a ballpoint pen, an unbent paper clip or something similar, press the MODE button [n] repeatedly until one of the two screens below appears.



Using either the UP or DOWN button [o] the desired receiving frequency or channel number can be set. Tapping the button steps through the frequency or channel number one at a time while pressing and holding the button in moves through the frequencies or channel numbers rapidly. There are 188 different frequencies or channel numbers to choose from. Once the desired frequency or channel number has been determined, be certain to set both the transmitter and the receiver to match.

USING THE 2000XT TRANSMITTER'S CONTROLS AND DISPLAY

A. Power

The POWER ON/OFF switch [r] turns the 2000XT ON or OFF.

B. Audio

Prior to turning the 2000XT ON it is best to set the AUDIO switch [q] To Off. When ready to begin transmitting, switch to ON. The OFF position acts as a “mute” maintaining the RF signal but turning off the audio.

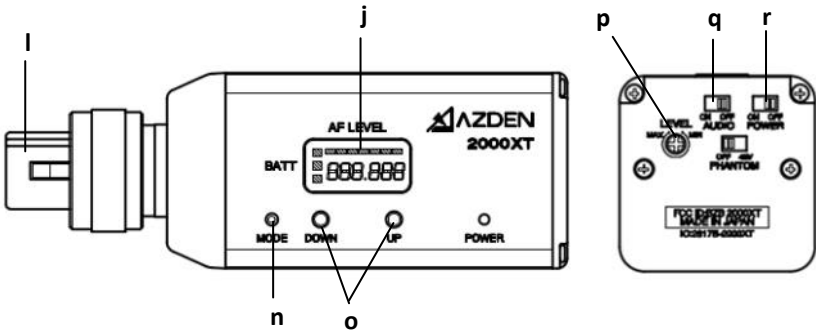

C. MIC Connector/Locking Ring

This 3-pin XLR connector [l] is the microphone input. Any low impedance microphone with a corresponding connector can be attached here. If the microphone requires external power (Phantom Power) the 2000XT can supply 48VDC. The XLR connector is wired with pin #1 as ground, pin #2 as audio + (and +48VDC when Phantom Power is ON) and pin #3 as audio.

Once the microphone is plugged into the 2000XT the locking ring [m] should be rotated clockwise until snug. To remove the microphone, first rotate the locking ring counterclockwise and then, while pressing the XLR release, pull the microphone straight away from the 2000XT.

D. Input Level Adjustment

This screwdriver adjustment [p] controls the input level of the microphone. Counterclockwise rotation reduces the input gain while clockwise rotation increases the input gain.

E. Display

In addition to showing the frequency and the channel number, the display [J] also shows other useful information.

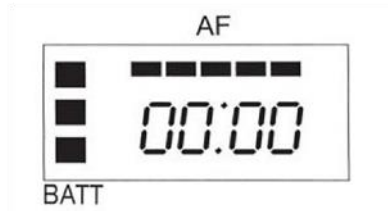

The LCD segments on the left show the approximate remaining battery life (from 1 to 3 segments) with 3 segments meaning maximum battery power. The bottom segment will blink when the battery power falls to less than 2.2VDC and indicates that it is time to replace the batteries. Azden recommends the use of Alkaline batteries only.

Across the top of the display, up to 5 segments will illuminate depending on the strength of the transmitted audio signal - From 2 (weak) to 5 (strong). The first (left) segment will light when the AUDIO switch is turned ON. The best audio is achieved when 4 to 5 segments are lit. If all 5 segments are lit continually, the signal is too strong and could overload the input of the receiver. Move the microphone further away from the sound source.

The display can also show the total number of hours of use (change to this display using the mode [n] button). To start, after choosing the TIME mode, press the UP [o] Button until the display shows 00:00. Then, each time the transmitter is turned ON the clock will keep track of the total hours and minutes used. This is a handy way of keeping track of battery life.

SPECIFICATIONS

2000URX

Receiving Frequency	638.125Mhz ~ 661.875 Mhz 188 Channels
Receiving Method	Space diversity double super heterodyne
Sensibility	0.8 μ V
Reference Deviation	\pm 5kHz
Max. Deviation	\pm 40kHz
Inter Modulation	65dB or more
Noise Reduction	Compander
Audio Output Level	4dBm MAX
Signal-to-noise Ratio	100dB or more (100% Dev)
Distortion Ratio	0.8% or less (100% Dev)
Antenna Connector	BNC Connector
Interface w/ Camera	D-sub 15pin (Si-s) D-sub 25 pin(Si)
Audio Output Jack	XLR-32-3 / 3.5mm stereo mini for monitoring
Power	DC 6V (4 AA batteries)
External Power	DC 11V ~ 15V(URX) DC 7V (Si-s) DC 12(10~17V) (Si)
Power Consumption	6V 240mA
LED	3 point RF level, diversity (A/B) (URX) 3 point AF level, Tone squelch (URX)
LCD	Receiving frequency, channel (URX) Frequency, Channel, RF Level w/ indicators, Diversity A or B, AF Level w/ indicators (URX Si-s, URX Si)
Size	98mm (W) x 109.5mm (H) x 40mm (D) (URX) 80mm (W) x 22mm (H) x 35mm (D) (URX/Si-s, URX/Si)
Weight	620g(URX) 245g(URX/Si-s)/240g(Si)

2000BT/XT

Transmitting Frequency	638.125MHz~661.875MHz (188channels)
Radio Type	F3E (FM)
Oscillation	Crystal-controlled-PLL-Synthesizer
Aerial Power	50mW
Tone Frequency	32.768 kHz
Noise Reduction	Compander
Mic In/Level	Hirose-4pin/ECM:-60dBu
Impedance	3.3 Ω
Frequency Response	50~15kHz \pm 1.5dB
LED	AF-Peak, Battery Low Alarm
LCD	Output frequency, channel, accumulated time
Power	DC 3V (2AABatteries)
Power Consumption	Less than 130ma
Battery Life	About 8 Hours (when used AA Batteries)

Due to constant improvements, specifications are subject to change without notice.

Licensing

Licensing of this, or any Azden wireless equipment is the user's responsibility. The ability to receive a license depends largely on the user's classification, application and frequency. Contact the appropriate agency (FCC in the USA) for further information.

Azden Corporation, 200 Valley Rd, Suite 101, Mt. Arlington, NJ 07856

tel - 973.810.3070 • fax - 973.810.3076 • email - sales@azdencorp.com • web - www.azden.com